

Freestanding Designer Fireplace

ecosmart⁺
Fire

Pillar Series



ecosmartfire.com

Pillar Series Design features



1. Surround Finishes

Choose from real oak veneer, white Carrara marble from Italy, and black Nero Portoro from Turkey, both with brushed brass trim and bracket accents.

Configurations

Available in two heights: 604mm (23.8 inch), and 484mm (19.1 inch) depending on your space and unique requirements.

No Flue, No Chimney, No Electricity Connection

Our freestanding fireplaces offer an easy and immediate, environmentally friendly solution to adding warmth and ambiance to any location.



2. Lamp-like aesthetic

Pillar-style base reminiscent of a floor lamp, with large suspended glass surround in lampshade-style for flame-illumination and striking visual impact.

Portable Fireplace

Fully portable, you can move the fireplace between rooms and outdoor spaces, or store away when not needed.

Perfectly paired or standalone statement

An edgy, characterful portable fireplace that can feature alongside other furniture or be used as a centerpiece fire to decorate or define a room.

3. Burner Colours

Available with a Stainless Steel or Black Burner.

Environmentally-Friendly

Bioethanol fireplaces use an environmentally-friendly, renewable energy source that burns clean and delivers warming heat. You and your guests will enjoy the ambiance and tranquility of a real fire, without the hassles of burning real wood - no more embers, ash, and soot to clean up.

Global Compliance

This model complies with existing standards in the USA, Europe, UK and Australia. O-TL listed to UL 1370, EN 16647 BSI Certified and ACCC Safety Mandate compliant.

Included Accessories



Jerry Can with Safety Spout & e-NRG bottle adaptor



Lighting Rod & Lighter



Jerry Can Spout Extension





Disclaimer. All product specifications and data are subject to change without notice and believed to be correct at the time of publication. MAD Design Group (MDG), its affiliates, agents, and employees, and all persons acting on its or their behalf (collectively, "MAD Design Group"), disclaim any and all liability for any errors, inaccuracies or incompleteness contained herein or in any other disclosure relating to any product. MDG disclaims any and all liability arising out of the use or application of any product described herein or of any information provided herein to the maximum extent permitted by law. The product specifications do not expand or otherwise modify MDG's terms and conditions of purchase, including but not limited to the warranty expressed therein, which apply to these products. No license, express or implied, by estoppel or otherwise, to any intellectual property rights is granted by this document or by any conduct of MDG. Customers using or selling MDG products not expressly indicated for use in such applications do so entirely at their own risk and agree to fully indemnify MDG for any damages arising or resulting from such use or sale. Please contact authorised personnel from MDG to obtain written terms and conditions regarding products designed for such applications. Images are indicative only.

Pillar 3T Specifications

Modern industrial-style, clean-burning indoor fire with side lamp-like aesthetic, adding texture and warmth to any room.

Burner Ventilation and Efficiency*

Dimensions L x W x H mm/in	Compatible Burner	Fuel Capacity	Heats on Average (Indoors)	Thermal Output Net (MAX)	Approx. Burn Time	Minimum Room Size
412 x 412 x 604 16.2 x 16.2 x 23.8	AB3	2.5 L [0.7 Gals]	Over 20 m ² [215 ft ²]	6.14 MJ/h 5,800 BTU/h 1.7 kW	8 - 11 hours	40 m ³ [1,413 ft ³]

Application	Indoor Only
Surround Colours	 Black Marble ESF.D.PLR3.T.MBB  White Marble ESF.D.PLR3.T.MBW  Oak ESF.D.PLR3.T.OK
Burner Colours	 Stainless Steel  Black
Materials	Real oak veneer (0.3mm), white Carrara marble from Italy, or black Nero Portoro marble from Turkey, Stainless Steel with Brushed Brass Plated Brackets, Grade 304 Stainless Steel Burner with optional Black Ceramic Coating, Borosilicate Glass Fire Screen
Approx. Weight	Oak 15.3kg [33.7lbs] / Marble 66.9kg [147.2lbs] Weight includes burner.
Fuel Type	e-NRG Bioethanol / e-NRG.com

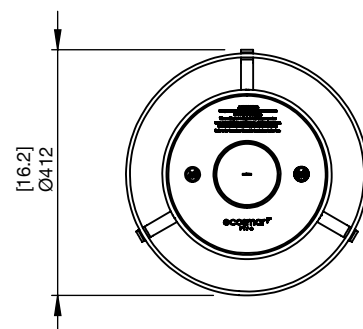
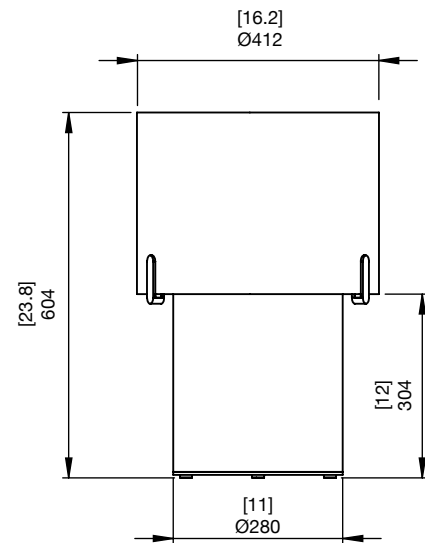

*These values are indicative only and may vary depending on the model purchased, installation, and the seasonal resource used to manufacture e-NRG.
This model can be permanently located into a fixed position.
This model complies with existing standards in the USA, Europe, UK and Australia. O-TL listed to UL 1370, EN 16647 BSI Certified and ACCC Safety Mandate compliant.







FOR MORE INFORMATION PLEASE REFERENCE THE CLEARANCE & INSTALLATION MANUAL



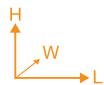

Disclaimer: All product specifications and data are subject to change without notice and believed to be correct at the time of publication. MAD Design Group (MDG), its affiliates, agents, and employees, and all persons acting on its or their behalf (collectively, "MAD Design Group"), disclaim any and all liability for any errors, inaccuracies or incompleteness contained herein or in any other disclosure relating to any product. MDG disclaims any and all liability arising out of the use or application of any product described herein or of any information provided herein to the maximum extent permitted by law. The product specifications do not expand or otherwise modify MDG's terms and conditions of purchase, including but not limited to the warranty expressed therein, which apply to these products. No license, express or implied, by estoppel or otherwise, to any intellectual property rights is granted by this document or by any conduct of MDG. Customers using or selling MDG products not expressly indicated for use in such applications do so entirely at their own risk and agree to fully indemnify MDG for any damages arising or resulting from such use or sale. Please contact authorised personnel from MDG to obtain written terms and conditions regarding products designed for such applications. Images are indicative only.

Pillar 3L Specifications

An edgy, characterful portable fireplace that can feature alongside other furniture or be used as a centerpiece fire to decorate or define a room.

Burner Ventilation and Efficiency*

 Dimensions L x W x H mm/in	 Compatible Burner	 Fuel Capacity	 Heats on Average (Indoors)	 Thermal Output Net (MAX)	 Approx. Burn Time	 Minimum Room Size
412 x 412 x 484 16.2 x 16.2 x 19.1	AB3	2.5 L [0.7 Gals]	Over 20 m ² [215 ft ²]	6.14 MJ/h 5,800 BTU/h 1.7 kW	8 - 11 hours	40 m ³ [1,413 ft ³]

Application	Indoor Only
Surround Colours	 Black Marble ESF.D.PLR3.L.MBB  White Marble ESF.D.PLR3.L.MBW  Oak ESF.D.PLR3.L.OK
Burner Colours	 Stainless Steel  Black
Materials	Real oak veneer (0.3mm), white Carrara marble from Italy, or black Nero Portoro marble from Turkey, Stainless Steel with Brushed Brass Plated Brackets, Grade 304 Stainless Steel Burner with optional Black Ceramic Coating, Borosilicate Glass Fire Screen
Approx. Weight	Oak 14.5kg [31.9lbs] / Marble 46.9kg [103.2lbs] Weight includes burner.
Fuel Type	e-NRG Bioethanol / e-NRG.com

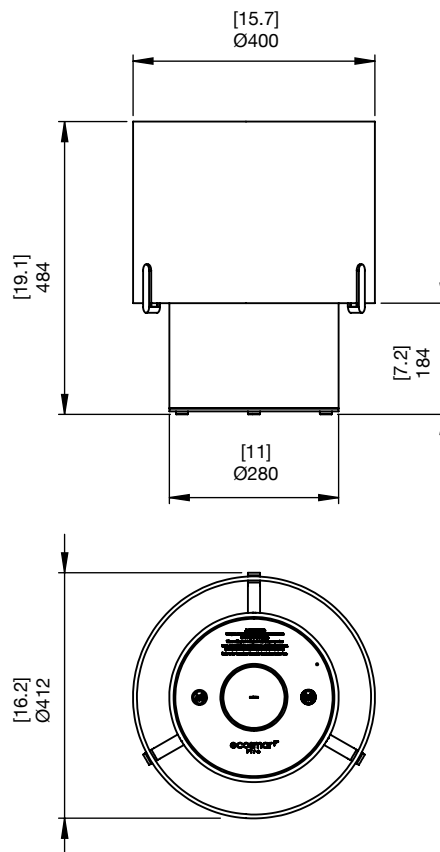

*These values are indicative only and may vary depending on the model purchased, installation, and the seasonal resource used to manufacture e-NRG.
This model can be permanently located into a fixed position.
This model complies with existing standards in the USA, Europe, UK and Australia. O-TL listed to UL 1370, EN 16647 BSI Certified and ACCC Safety Mandate compliant.

FOR MORE INFORMATION PLEASE REFERENCE THE CLEARANCE & INSTALLATION MANUAL

Disclaimer: All product specifications and data are subject to change without notice and believed to be correct at the time of publication. MAD Design Group (MDG), its affiliates, agents, and employees, and all persons acting on its or their behalf (collectively, "MAD Design Group"), disclaim any and all liability for any errors, inaccuracies or incompleteness contained herein or in any other disclosure relating to any product. MDG disclaims any and all liability arising out of the use or application of any product described herein or of any information provided herein to the maximum extent permitted by law. The product specifications do not expand or otherwise modify MDG's terms and conditions of purchase, including but not limited to the warranty expressed therein, which apply to these products. No license, express or implied, by estoppel or otherwise, to any intellectual property rights is granted by this document or by any product of MDG. Customers using or selling MDG products not expressly indicated for use in such applications do so entirely at their own risk and agree to fully indemnify MDG for any damages arising or resulting from such use or sale. Please contact authorised personnel from MDG to obtain written terms and conditions regarding products designed for such applications. Images are indicative only.